



ANLY TIMER

H3D-M MULTI-FUNCTION ANALOGUE TIMER



CHARACTERISTICS :

- Wide operating voltage range, AC 24-240V, DC 12-240V
- 7 output modes :
On-delay
Control contact OFF-delay
Interval
Trailing edge interval
Flasher starting with ON
Flasher starting with OFF
Single shot
- 7 time range, from 1 second to 100 hour
- 17.5 mm thin body design
- UL, C-UL recognized and CE certified

SPECIFICATION :

Operating voltage	AC(V): 24-240 DC(V): 12-240
Allowable operating voltage range	90~110% of rated operating voltage
Rated frequency	50 / 60 Hz
Contact rating	250VAC 8A (resistive load)
Reset time	MAX 0.1s
Power consumption	Approx. 1.9VA
Life	Mechanical: 5,000,000 times Electrical: 100,000 times
Ambient temperature	-10 ~ +50°C (without condensation & freezing)
Ambient humidity	MAX 85%RH (without condensation)
Altitude	MAX 2000m
Weight	Approx. 62g

TYPE SELECTION :

Type	H3D-M
Time range	1s / 10s / 100s / 10m / 100m / 10h / 100h
Output contact	1C
Output mode	7 Mode

CONNECTION :

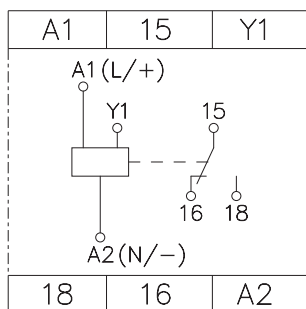

TIMING CHART :

Mode A: On-delay,

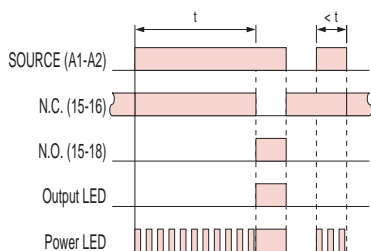

Mode B: Flasher starting with OFF,

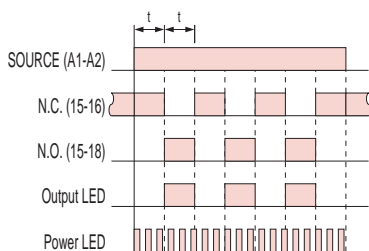

Mode B2: Flasher starting with ON,

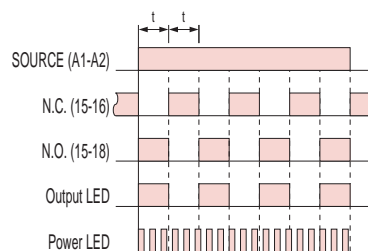

Mode D: Control contact OFF-delay,

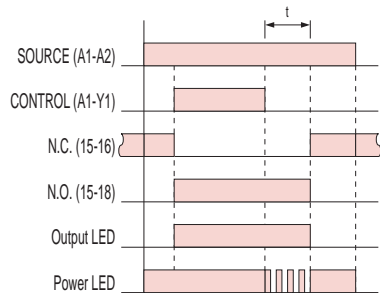

Mode D1: Trailing edge interval,

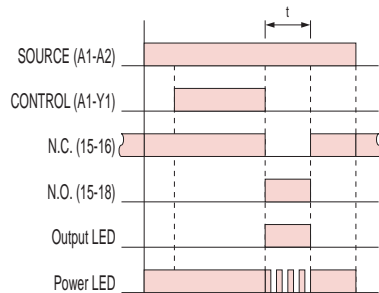

Mode E: Interval,

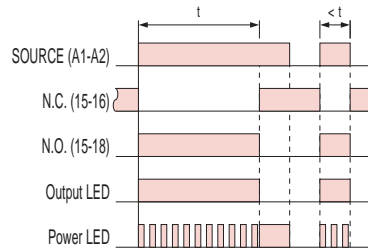

DIMENSIONS : (mm)

Mode J1: Single shot,

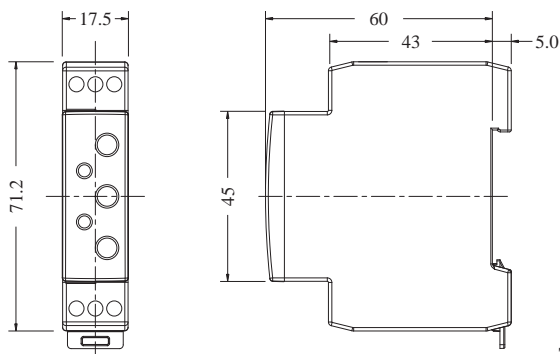
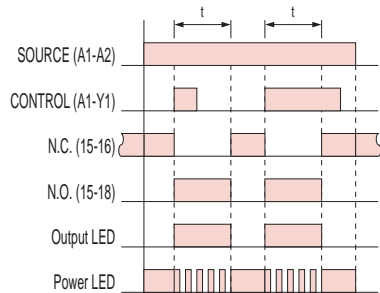

Tolerance: ±0.1

ANLY ELECTRONICS CO., LTD.

<http://www.anly.com.tw>

TAIWAN MAIN OFFICE : ANLY ELECTRONICS CO., LTD.

No.19, Lane 202, Fushou St., Xinzhuang Dist., New Taipei City 242, Taiwan
TEL: +886-2-2996-3202 FAX: +886-2-2996-2017

HONG KONG OFFICE : ANLY ELECTRONICS (HK) LTD.

Flat K, 13/F, Edward Mansion, 141 Prince Edward Road W., Kowloon, Hong Kong
TEL: +852-2397-2505 FAX: +852-2397-6080

CHINA OFFICE : ANLY TECHNOLOGY (WUXI) CO., LTD.

2F, Building A, Plot 1, No. 28, Zhanhong Rd., Xinwu Dist., Wuxi, Jiangsu, P.R.China
TEL: +86-510-85304801-3

MALAYSIA OFFICE : JUSTY ELECTRONICS (M) SDN. BHD.

No.1, Jalan 6/89B, Kawasan Perindustrian Trisegi, Batu 3 1/2 Off Jalan Sungei Besi, 57100 Kuala Lumpur, Malaysia
TEL: +60-3-7983-5758 FAX: +60-3-7981-5052

INDONESIA OFFICE : PT. ANLY ELECTRONICS INDONESIA

Jl. Pangeran Jayakarta 117/B9, Jakarta Pusat, 10730 Indonesia
TEL: +62-21-624-8436 FAX: +62-21-626-1228

NO. H3DM-W-A